

Orion-Tr Smart DC-DC charger isolated

250 / 400 Watt

With 3-stage battery charge algorithm

www.victronenergy.com



Orion-Tr Smart 12/12-30



Orion-Tr Smart 12/12-30

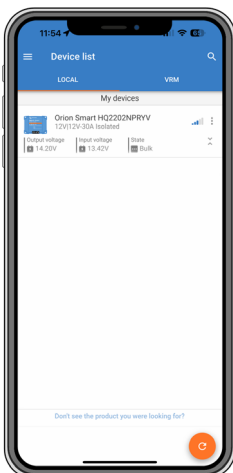

The Orion-Tr Smart isolated DC-DC charger serves as a DC-DC battery charger or as a power supply (it is also designed for use as a constant voltage source), offering a wide input and output voltage range. This is especially significant in the case of vehicles with a Euro 5 or Euro 6 smart alternator, which often supplies too low charging voltage even when the engine is running or when extended cable lengths, as is often the case in boats and RVs, lead to voltage drops. In such scenarios, precise and controlled charging is imperative to fully charge the service battery while protecting the starter/input battery from discharge.

Bluetooth Smart enabled

- Any Bluetooth enabled smart phone, tablet or other device can be used to monitor, to change settings and to update the charger when new software features become available.
- Instant Readout: The [VictronConnect App](#) can display key data, including warnings and alarms, on the Device list page without the need to connect to the product.

Fully programmable

- Battery charge algorithm (configurable) or fixed output.
- Smart alternator compatibility: engine running detection mechanism.

Adaptive 3-stage charge algorithm: bulk – absorption – float

- For lead acid batteries it is important that during shallow discharges the absorption time is kept short in order to prevent overcharging of the battery. After a deep discharge the absorption time is automatically increased to make sure that the battery is completely recharged.
- For lithium batteries absorption time is fixed, default 2 hours.
- Alternatively, a fixed output voltage can be chosen.

Suitable for use in vehicles with a smart alternator (Euro 5 and Euro 6 engines)

The built-in engine shutdown detection will stop the converter when the engine is not running. This prevents unwanted discharge of the starter battery (see manual for details).

Remote on/off

A remote on/off switch or relay contact can be connected to a two-pole connector.

Alternatively, the H terminal (right) of the two-pole connector can be switched to battery plus, or the L terminal (left) of the two pole connector can be switched to battery minus (or the chassis of a vehicle, for example).

All models are short circuit proof and can be paralleled to increase output current

An unlimited number of units can be connected in parallel.

High temperature protected

The output current will reduce at high ambient temperature.

IP43 protection

When installed with the screw terminals oriented downwards.

Screw terminals

No special tools needed for installation.

Input fuse (not replaceable)

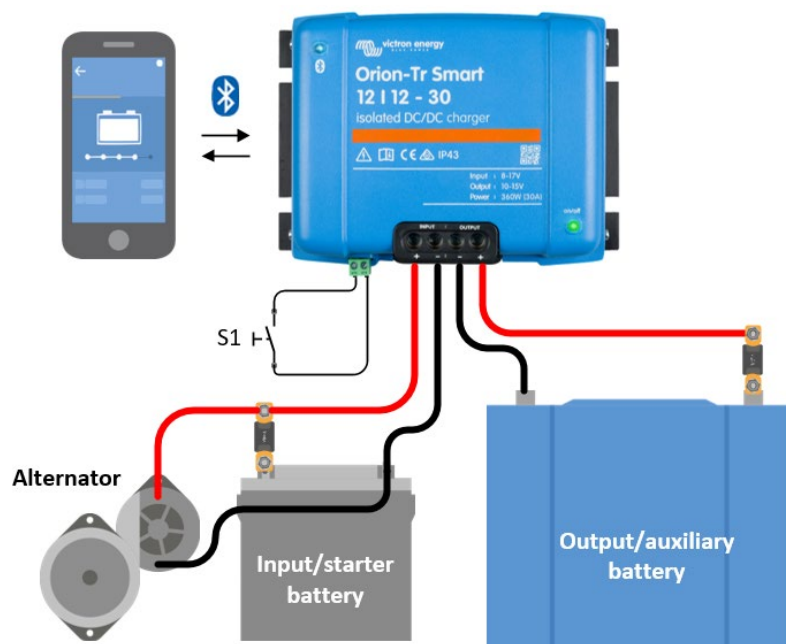

Orion-Tr Smart Chargers Isolated 220 - 280 Watt	12/12-18 (220 W)	12/24-10 (240 W)	24/12-20 (240 W)	24/24-12 (280 W)
Input voltage range ⁽¹⁾	8-17 V	8-17 V	16-35 V	16-35 V
Under voltage shut down	7 V	7 V	14 V	14 V
Under voltage restart	7,5 V	7,5 V	15 V	15 V
Nominal output voltage	12,2 V	24,2 V	12,2 V	24,2 V
Output voltage adjust range	10-15 V	20-30 V	10-15 V	20-30 V
Output voltage tolerance	+/- 0,2 V			
Output noise	2 mV rms			
Cont. output current at nominal output voltage and 40 °C	18 A	10 A	20 A	12 A
Maximum output current (10 s) at nominal output voltage minus 20 %	25 A	15 A	25 A	15 A
Short circuit output current	40 A	25 A	50 A	30 A
Cont. output power at 25 °C	280 W	280 W	300 W	320 W
Cont. output power at 40 °C	220 W	240 W	240 W	280 W
Efficiency	87 %	88 %	88 %	89 %
No load input current	< 80 mA	< 100 mA	< 100 mA	< 80 mA
Standby current	Less than 1mA			
Can be used as power supply	Yes, output voltage can be set with Bluetooth			
Galvanic isolation	200 VDC between input, output and case			
Operating temperature range	-20 to +55 °C (derate 3 % per °C above 40 °C)			
Humidity	Max. 95 % non-condensing			
DC connection	Screw terminals			
Maximum cable cross-section	16 mm ² AWG6			
Weight	1,3 kg (3 lb)			
Dimensions h x w x d	130 x 186 x 70 mm (5.1 x 7.3 x 2.8 inch)			
Protection category	IP43 (electronic components), IP22 (connection area)			
Standards: Safety Emission / Immunity Automotive Directive	EN 60950 EN 61000-6-3, EN 55014-1 / EN 61000-6-2, EN 61000-6-1, EN 55014-2 ECE R10-5			

Orion-Tr Smart Chargers Isolated 360 - 400 Watt	12/12-30 (360 W)	12/24-15 (360 W)	12/48-8 (360 W)	24/12-30 (360 W)	24/24-17 (400 W)	24/48-8,5 (400 W)	48/12-30 (360 W)	48/24-16 (380 W)	48/48-8 (380 W)
Input voltage range ⁽¹⁾	8-17 V	8-17 V	8-17 V	16-35 V	16-35 V	16-35 V	32-70 V	32-70 V	32-70 V
Under voltage shut down	7 V	7 V	7 V	14 V	14 V	14 V	28 V	28 V	28 V
Under voltage restart	7,5 V	7,5 V	7,5 V	15 V	15 V	15 V	30 V	30 V	30 V
Nominal output voltage	12.2 V	24.2 V	48.2 V	12.2 V	24.2 V	48.2 V	12.2 V	24.2 V	48.2 V
Output voltage adjust range	10-15 V	18-30 V	40-60 V	10-15 V	18-30 V	40-60 V	10-15 V	18-30 V	40-60 V
Output voltage tolerance	+/- 0,2 V								
Output noise	2 mV rms								
Cont. output current at nominal output voltage and 40 °C	30 A	15 A	8 A	30 A	17 A	8,5 A	30 A	16 A	8 A
Maximum output current (10 s) at nominal output voltage minus 20 %	40 A	25 A	15 A	45 A	25 A	15 A	40 A	25 A	15 A
Short circuit output current	60 A	40 A	25 A	60 A	40 A	25 A	60 A	40 A	25 A
Cont. output power at 25 °C	430 W	430 W	430 W	430 W	480 W	480 W	430 W	430 W	430 W
Cont. output power at 40 °C	360 W	360 W	360 W	360 W	400 W	400 W	360 W	380 W	380 W
Efficiency	87%	88%	89%	88%	89%	89%	87%	89%	89%
No load input current	< 80mA	< 100mA	< 220mA	< 100mA	< 80mA	< 120mA	< 80mA	< 80mA	< 80mA
Standby current	Less than 1 mA								
Can be used as power supply	Yes, output voltage can be set with Bluetooth								
Galvanic isolation	200 VDC between input, output and case								
Operating temperature range	-20 to +55 °C (derate 3 % per °C above 40 °C)								
Humidity	Max. 95 % non-condensing								
DC connection	Screw terminals								
Maximum cable cross-section	16 mm ² (AWG6)								
Weight	12 V input and/or 12 V output models: 1,8 kg (4 lb) Other models: 1,6 kg (3.5 lb)								
Dimensions h x w x d	12 V input and/or 12 V output models: 130 x 186 x 80 mm (5.1 x 7.3 x 3.2 inch) Other models: 130 x 186 x 70 mm (5.1 x 7.3 x 2.8 inch)								
Protection category	IP43 (electronic components), IP22 (connection area)								
Standards: Safety Emission / Immunity Automotive Directive	EN 60950 EN 61000-6-3, EN 55014-1 / EN 61000-6-2, EN 61000-6-1, EN 55014-2 ECE R10-5								

1) If set to nominal or lower than nominal, the output voltage will remain stable within the specified input voltage range (buck-boost function). If the output voltage is set higher than nominal by a certain percentage, the minimum input voltage at which the output voltage remains stable (does not decrease) increases by the same percentage.
Note 1) The VictronConnect App will not display current in or current out.
Note 2) The Orion-Tr Smart is not equipped with a VE.Direct port.